

Cleaning instructions

Rex-Royal S300 | Rex-Royal S500
with AutoClean

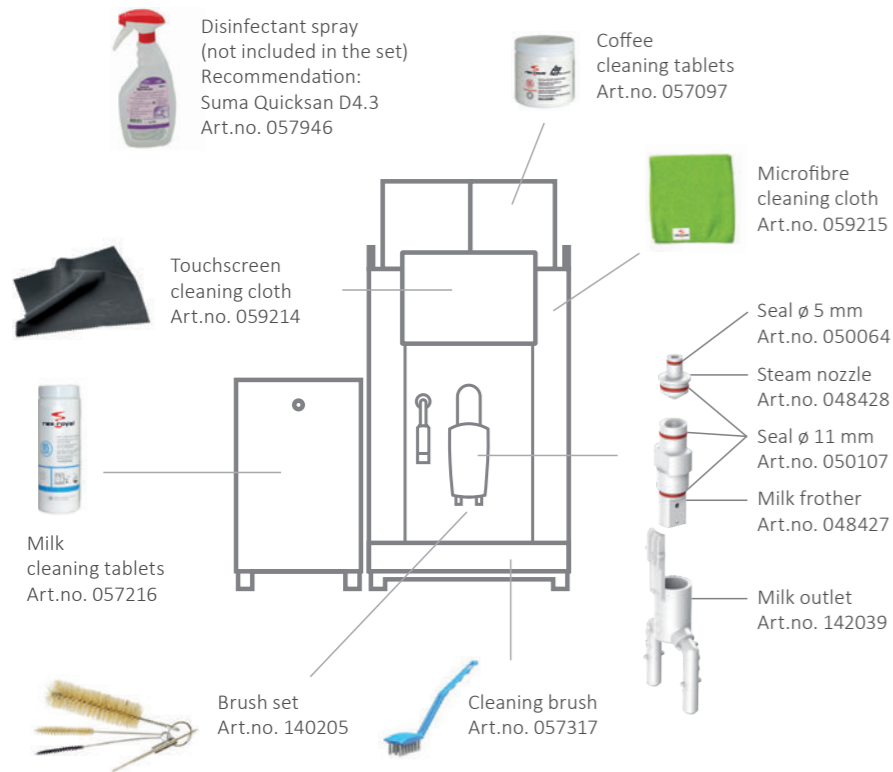

Important information

- Once every day, it is necessary to clean all systems that have been used at least once.
- Depending on the setting, cleaning must be started manually or the fully automatic coffee machine requests cleaning at the programmed time.
- Use only the cleaning agents listed above, as they are optimally adapted to the automatic cleaning program. Before using the cleaning agents, observe the safety instructions on the packaging. Please ask for the safety data sheets if the safety instructions are not printed in your language.
- The ingredients of the cleaning agents can cause eye and skin irritation and be detrimental to health if inhaled or swallowed.
- The cleaning agents must be kept out of reach of children and under lock and key, and are only allowed to be accessible to authorised persons. The manufacturer is not liable for misuse.
- Wear protective gloves whenever possible.
- Never open the front door during cleaning and never remove the residual water tray unless requested to do so by the fully automatic coffee machine.
- Do not switch off the fully automatic coffee machine during cleaning.
- There is a risk of burns from hot liquids or steam. Do not touch any outlet during automatic cleaning, do not reach into the dispensing area. Only touch the touchscreen when requested to do so.
- Do not clean the fully automatic coffee machine with a water jet or high-pressure cleaner and never pour water over it.
- Keep the microfibre cloth and cleaning brushes in a clean and dry condition. Wash the microfibre cloth and the cleaning brushes regularly.

Rex-Royal hygiene concept

Cleaning must be carried out correctly for consistently perfect coffee pleasure. Follow the information in these cleaning instructions and on the touchscreen of your fully automatic coffee machine to maintain its hygiene. Please contact your service partner or Rex-Royal AG if you have any questions.

Please use cleaning gloves for reasons of hygiene.

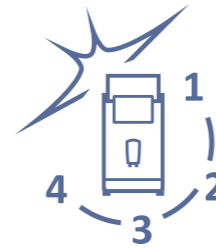

- 1 Soaking/prewashing**
Disassemble the parts to be cleaned and place them in warm water. If necessary, use a mild cleaning agent.
- 2 Removing residues**
Remove all residues using the cleaning brushes and cleaning cables, and then rinse with warm water.
- 3 Drying**
Dry all parts thoroughly with the green microfibre cloth.
- 4 Disinfecting**
1 Spray undiluted product onto a clean, dry surface. Ensure complete wetting.
2 Allow to act for 5 minutes (according to EN 1276, EN14476 and DGHM).
3 Allow surfaces to air-dry, if necessary redry thoroughly.

Automatic cleaning program

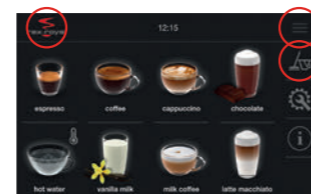

Press and hold MENU or LOGO for at least 5 seconds. Then press the CLEANING button.

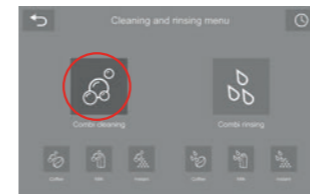

Press the COMBI-CLEANING button to start cleaning.



Remove, empty, clean and re-insert the grounds container. After that, press the arrow key to go to the next step.



Open the tablet chute and insert a coffee cleaning tablet. Then place a milk cleaning tablet in the empty cleaning container.



The coffee machine is cleaning... The next step will shortly be displayed on the screen.



Remove the parts as shown on the display, clean them according to the hygiene concept and reassemble them. Follow the detailed instructions in the "Removal of the instant mixing unit" on the back page.

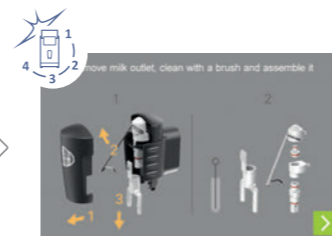

Remove the parts as shown on the display, clean them according to the hygiene concept and reassemble them. Follow the detailed instructions "Removal of the milk outlet / coffee outlet" on the back page.



The fully automatic coffee machine performs an instant rinsing.

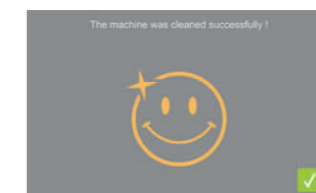

Cleaning has been completed. Touching the touchscreen completes the program.

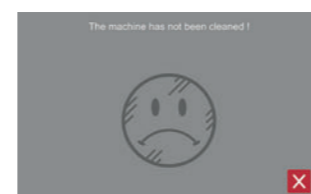

If mandatory cleaning has been activated, this message is displayed if necessary.



If the cleaning process has been interrupted, this message appears. Touch the touchscreen to continue cleaning.

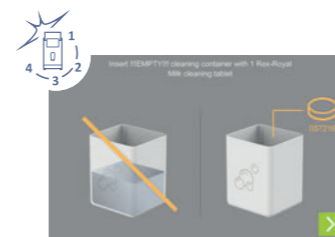

Empty, clean and dry the cleaning container. Also remove dirt and any ice build-up from the refrigerator.



Removal of the milk outlet / coffee outlet

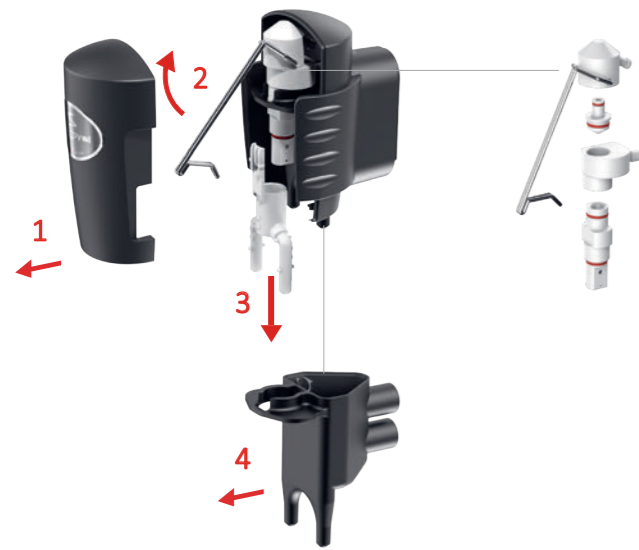

Removal of the instant mixing unit / instant mixer

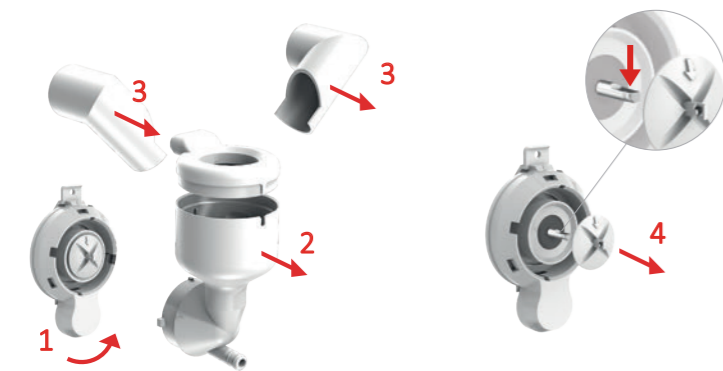

Use of cleaning utensils

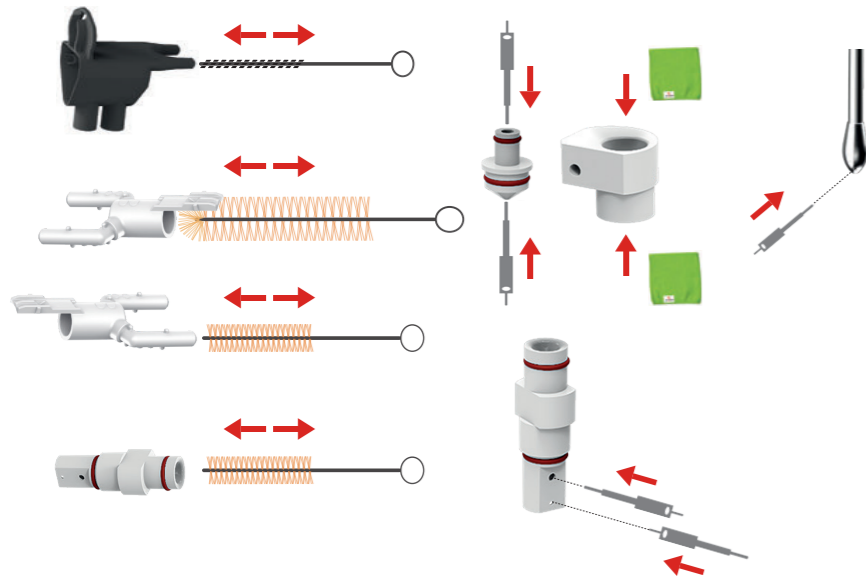

Daily cleaning

The following components must be cleaned manually every day during automatic cleaning. Follow the Rex-Royal hygiene concept as described on the first page.



Empty and clean the grounds container.



Empty the milk and clean the milk container.



Remove and clean the milk frother. See "Removal of the milk outlet"!



Remove and clean the instant mixing unit. See "Removal of the instant mixing unit"!

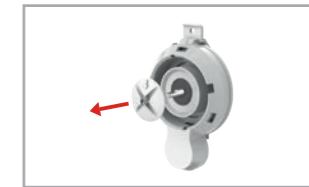

Remove and clean the instant mixer. See "Removal of the instant mixer"!
Make sure that the instant mixer has been inserted correctly after cleaning.

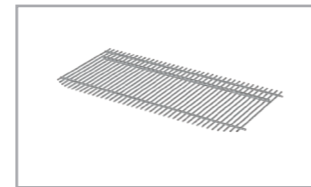

Remove the drip grid from the residual water tray and clean it.



Empty and clean the residual water tray.



Use the microfiber cloth to clean the cooling unit, the milk aspiration and pipes, then spray in the disinfection spray and allow to dry.

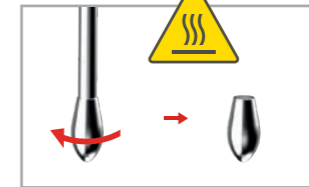

Danger of burns!
Switch off the fully automatic coffee machine.
Unscrew the steam nozzle and clean the individual parts completely inside and out. Then screw on the steam nozzle again.

Weekly cleaning



Remove and clean the steam nozzle in the milk frother. See "Removal of the milk outlet"!



Remove and clean the coffee outlet. See "Removal of the coffee outlet"!



Remove the coffee container and instant container; remove any residues with a mild cleaning agent and dry well.



Clean the outside of the fully automatic coffee machine with the microfiber cloth. Spray in disinfectant spray and allow to dry.

Reinigungsanleitung

Rex-Royal S300 | Rex-Royal S500
mit AutoClean

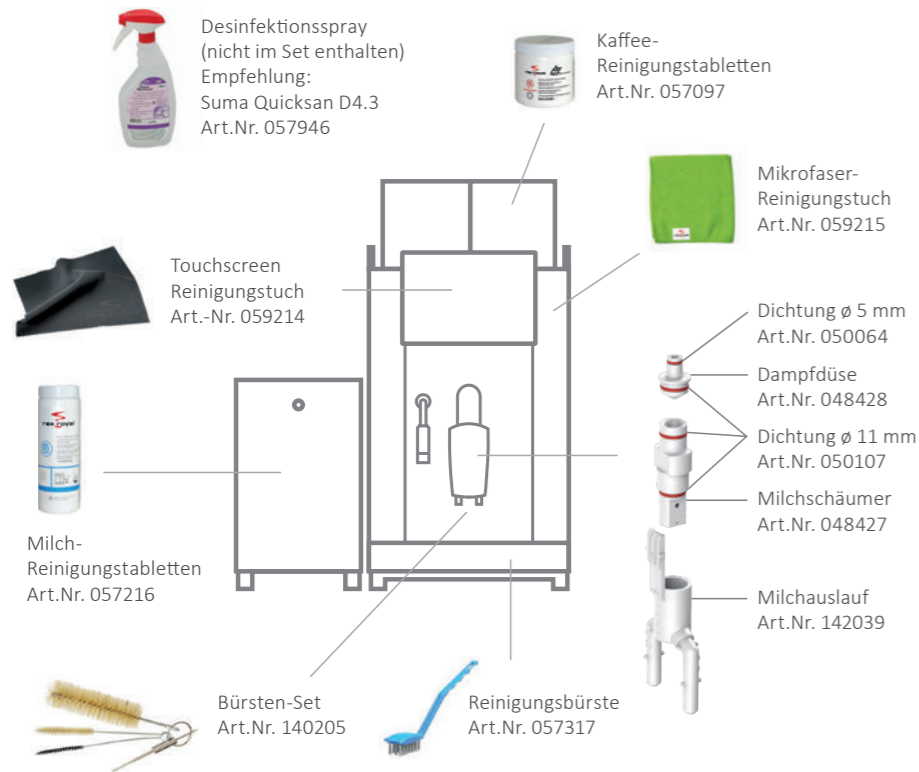

Wichtige Informationen

- Eine tägliche Reinigung aller Systeme ist erforderlich, wenn diese mindestens einmal benutzt worden sind.
- Je nach Einstellung muss die Reinigung manuell gestartet werden oder der Kaffeevollautomat verlangt zur programmierten Zeit eine Reinigung.
- Es dürfen nur die oben aufgeführten Reinigungsmittel verwendet werden, da diese optimal auf das automatische Reinigungsprogramm abgestimmt sind. Vor der Verwendung der Reinigungsmittel müssen die Sicherheitshinweise auf der Verpackung beachtet werden. Verlangen Sie die Sicherheitsdatenblätter, falls die Sicherheitshinweise in Ihrer Sprache nicht abgedruckt sind.
- Die Bestandteile der Reinigungsmittel können Reizungen der Augen und Haut sowie Gesundheitsschäden beim Einatmen und Verschlucken hervorrufen.
- Die Reinigungsmittel müssen für Kinder unerschikbaar, unter Verschluss aufbewahrt werden und dürfen nur für autorisierte Personen zugänglich sein. Der Hersteller haftet nicht bei Missbrauch.
- Wenn immer möglich Schutzhandschuhe tragen.
- Während der Reinigung niemals die Fronttüre öffnen und niemals die Restwasserschale entfernen, ausser Sie werden von dem Kaffeevollautomaten dazu aufgefordert.
- Kaffeevollautomaten während der Reinigung nicht ausschalten.
- Es besteht Verbrennungsgefahr durch heisse Flüssigkeiten oder Dampf. Während der automatischen Reinigung darf kein Auslauf berührt werden. Nicht in den Ausgabebereich greifen. Berühren Sie den Touchscreen nur, wenn Sie dazu aufgefordert werden.
- Den Kaffeevollautomaten nicht mit einem Wasserstrahl oder Hochdruckreiniger reinigen und niemals mit Wasser übergießen.
- Mikrofaser- und Reinigungsbürsten regelmässig waschen und stets in einem sauberen und trockenen Zustand halten.

Rex-Royal Hygienekonzept

Gleichbleibend perfekter Kaffeegenuss setzt eine korrekt durchgeführte Reinigung voraus. Befolgen Sie die Informationen in dieser Reinigungsanleitung und auf dem Touchscreen Ihres Kaffeevollautomaten, um dessen Hygiene zu erhalten. Wenden Sie sich bei Unklarheiten an Ihren Servicepartner oder an die Rex-Royal AG.

Verwenden Sie bitte Reinigungshandschuhe aus hygienischen Gründen.

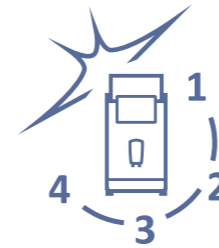

- 1 Einweichen/Vorspülen**
Die zu reinigenden Teile zerlegen und in warmem Wasser einlegen. Gegebenenfalls einen milden Reiniger verwenden.
- 2 Rückstände entfernen**
Unter Verwendung der Reinigungsbürsten und Reinigungswellen alle Rückstände entfernen und anschliessend mit warmem Wasser spülen.
- 3 Trocknen**
Mit dem grünen Mikrofaser- und Reinigungstuch alle Teile gut abtrocknen.
- 4 Desinfizieren**
1 Produkt unverdünnt auf die saubere, trockene Oberfläche sprühen. Auf vollständige Benetzung achten.
2 5 Minuten einwirken lassen (gemäss EN 1276, EN14476 und DGHM).
3 Oberflächen an der Luft trocknen lassen, gegebenenfalls nachtrocknen.

Automatisches Reinigungsprogramm



MENÜ oder LOGO für mindestens 5 Sekunden gedrückt halten. Danach die Taste REINIGUNG drücken.

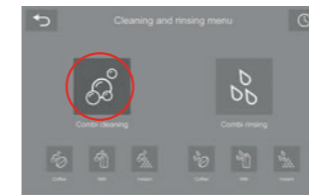

Durch Drücken der KOMBI-REINIGUNGS-Taste wird die Reinigung gestartet.



Den Satzbehälter entnehmen, leeren, reinigen und wieder einsetzen. Anschliessend die Pfeiltaste drücken, um zum nächsten Schritt zu gelangen.

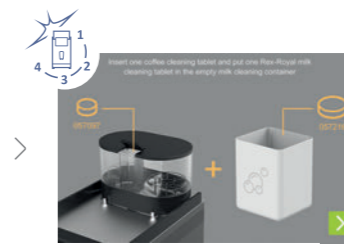

Den Tabletteneinwurf öffnen und eine Kaffee-Reinigungstablette einwerfen. Dann eine Milch-Reinigungstablette in den leeren Reinigungsbehälter einwerfen.



Die Kaffeemaschine reinigt... Der nächste Schritt wird in Kürze auf dem Bildschirm angezeigt.

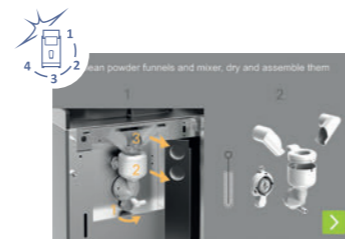

Die Teile ausbauen wie auf dem Display dargestellt, nach dem Hygienekonzept reinigen und wieder montieren. Befolgen Sie die detaillierte Anleitung „Demontage Instant-Mischeinheit“ auf der Rückseite.



Die Teile ausbauen wie auf dem Display dargestellt, nach dem Hygienekonzept reinigen und wieder montieren. Befolgen Sie die detaillierte Anleitung „Demontage Milchauslauf / Kaffeeauslauf“ auf der Rückseite.



Der Kaffeevollautomat führt eine Instantspülung durch.

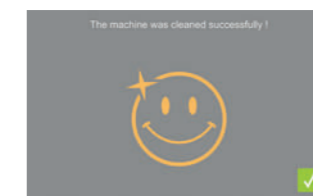

Die Reinigung wurde erfolgreich durchgeführt. Durch das Berühren des Touchscreens wird das Programm abgeschlossen.

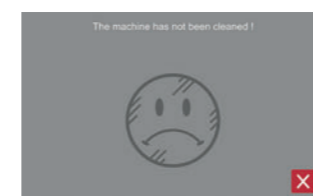

Wurde die Zwangsreinigung aktiviert, dann wird bei Bedarf diese Meldung angezeigt.



Wurde der Reinigungsvorgang unterbrochen, dann erscheint diese Meldung. Durch Berühren des Touchscreens wird die Reinigung fortgesetzt.

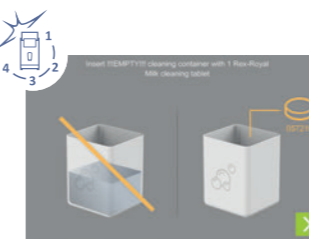

Reinigungsbehälter entleeren, reinigen und trocknen. Ebenfalls Schmutz und Vereisung im Kühlschrank entfernen.



Demontage Milch- und Kaffeeauslauf

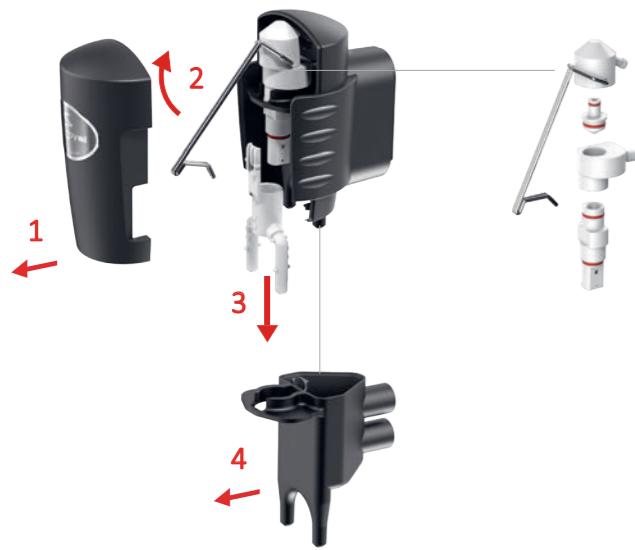

Demontage Instant-Mischeinheit / Instantmixer

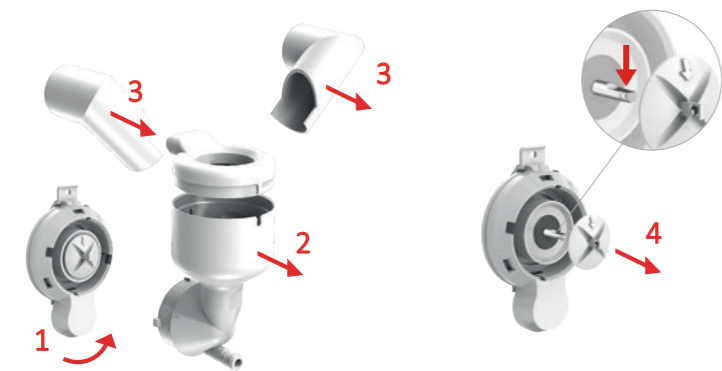

Verwendung der Reinigungsutensilien

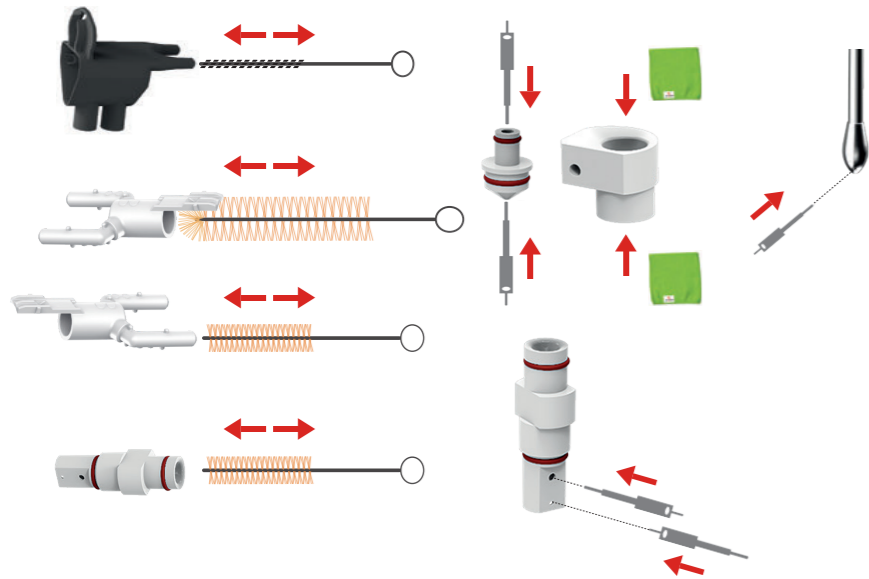

Tägliche Reinigung

Nachfolgende Komponenten müssen während der automatischen Reinigung täglich manuell gereinigt werden. Befolgen Sie hierfür das Rex-Royal Hygienekonzept wie auf der ersten Seite beschrieben.



Den Satzbehälter leeren und reinigen.



Die Milch entleeren und den Milchbehälter reinigen.



Den Milchaufschäumer demontieren und reinigen. Siehe „Demontage Milchauslauf“!



Die Instant-Mischeinheit demontieren und reinigen. Siehe „Demontage Instant-Mischeinheit“!

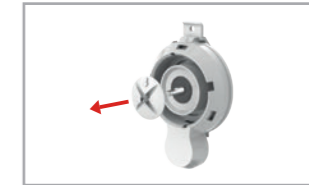

Den Instantmixer demontieren und reinigen. Siehe „Demontage Instantmixer“! Sicherstellen, dass der Instantmixer nach erfolgter Reinigung korrekt eingesetzt wurde.

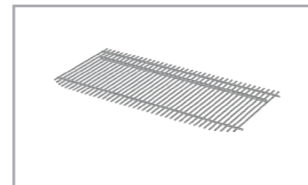

Tropfgitter von der Restwasserschale entnehmen und reinigen.



Restwasserschale leeren und reinigen.



Mit dem Mikrofasertuch die Kühleinheit, die Milch-Ansaugung und Leitungen reinigen. Anschliessend mit dem Desinfektionsspray einsprühen und trocknen lassen.



Verbrennungsgefahr!
Kaffeevollautomat ausschalten.
Dampfdüse abschrauben und Einzelteile innen und aussen vollständig reinigen. Anschliessend Dampfdüse wieder anschrauben.

Wöchentliche Reinigung



Die Dampfdüse im Milchaufschäumer demontieren und reinigen. Siehe „Demontage Milchauslauf“!



Den Kaffeeauslauf demontieren und reinigen. Siehe „Demontage Kaffeeauslauf“!



Kaffee- und Instantbehälter demontieren und mit einem milden Reiniger allfällige Rückstände entfernen. Gut trocknen.



Mit dem Mikrofasertuch den Kaffeevollautomaten aussen reinigen. Desinfektionsspray einsprühen und trocknen lassen.

Instructions de nettoyage

Rex-Royal S300 | Rex-Royal S500

avec AutoClean

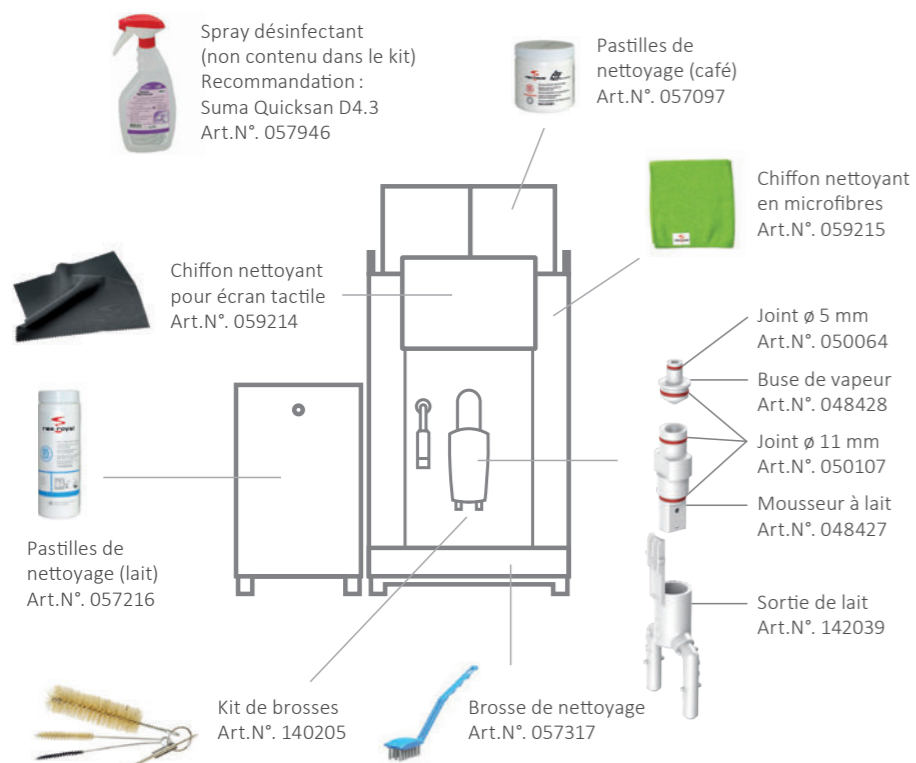

Informations importantes

- Un nettoyage quotidien est nécessaire pour tous les systèmes ayant été utilisés au moins une fois.
- En fonction des réglages, le nettoyage doit être lancé manuellement ou bien la machine à café automatique exige un nettoyage à une heure programmée.
- Utilisez uniquement les nettoyeurs listés ci-dessus, car ils sont adaptés de façon optimale au programme de nettoyage automatique. Avant l'utilisation des nettoyeurs, lire et observer les consignes de sécurité indiquées sur l'emballage. Si les consignes de sécurité ne sont pas rédigées dans votre langue, veuillez demander les fiches de données de sécurité.
- Les composants des nettoyeurs peuvent provoquer des irritations oculaires ou cutanées et nuire à la santé en cas d'inhalation et d'ingestion.
- Les nettoyeurs doivent être tenus hors de portée des enfants et être conservés sous clé et ils ne doivent être accessibles qu'aux personnes autorisées. Le fabricant ne pourra pas être tenu responsable des éventuels abus.
- Si possible, portez toujours des gants de protection.
- Pendant le nettoyage, n'ouvrez jamais la porte frontale et ne retirez jamais le bac de récupération d'eau résiduelle, sauf si la machine à café automatique le demande.
- N'éteignez pas la machine à café automatique pendant le nettoyage.
- Il existe un risque de brûlures dues aux liquides chauds ou à la vapeur. Pendant le nettoyage automatique, ne touchez aucune sortie et ne mettez pas les mains dans la zone de sortie produit. Ne touchez l'écran tactile que lorsque vous y êtes invité.
- Ne pas nettoyer la machine à café à l'aide d'un jet d'eau ou d'un nettoyeur à haute pression et ne jamais l'arroser avec de l'eau.
- Toujours garder le chiffon microfibre et les brosses de nettoyage propres et secs. Laver régulièrement le chiffon microfibre et les brosses de nettoyage.

Rex-Royal Concept hygiénique

Pour un goût de café toujours parfait, un nettoyage rigoureux est nécessaire. Observez les consignes énoncées dans les présentes instructions de nettoyage et affichées sur l'écran tactile de votre machine à café automatique pour préserver son hygiène. En cas de doute, contactez votre partenaire de service ou l'entreprise Rex-Royal AG.

Veuillez utiliser S.V.P. les gants de nettoyage pour des raisons d'hygiène !

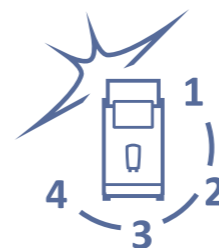

- Tremper / prélever**
Désassembler les pièces à nettoyer et les tremper dans de l'eau chaude. Si nécessaire, utiliser un nettoyeur doux.
- Enlever les résidus**
À l'aide des brosses et outils métalliques de nettoyage, éliminer tous les résidus et rincer ensuite avec de l'eau chaude.
- Séchage**
Avec le chiffon microfibre vert, bien sécher toutes les pièces.
- Désinfecter**
 - Pulvériser le produit non dilué sur la surface propre et sèche. Veiller à un mouillage complet.
 - Laissez agir pendant 5 minutes (conformément à EN 1276, EN14476 et DGHM).
 - Laissez sécher la surface à l'air ; si nécessaire, sécher manuellement.

Programme de nettoyage automatique

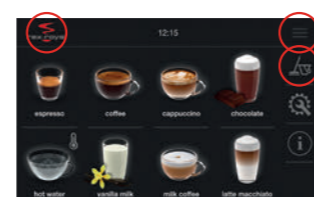

Maintenir la touche MENU ou LOGO appuyée pendant au moins 5 secondes. Appuyer ensuite sur la touche NETTOYAGE.

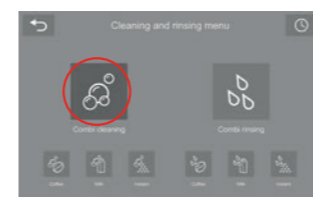

Appuyer sur la touche NETTOYAGE COMBI pour lancer la procédure de nettoyage.



Retirer, vider, nettoyer et remettre en place le bac à marc. Ensuite, appuyer sur la touche fléchée pour accéder à l'étape suivante.



Ouvrir le couvercle pour insertion de pastilles et y introduire une pastille de nettoyage café. Ensuite introduire une pastille de nettoyage lait dans le récipient de nettoyage vide.



La machine à café est en cours de nettoyage... L'étape suivante sera bientôt affichée à l'écran.



Démonter les pièces tel que décrit à l'écran, nettoyer selon le concept hygiénique et les remonter. Suivre les consignes détaillées « Démontage unité de mélange d'instantané » apposées sur la face arrière.



Démonter les pièces tel que décrit à l'écran, nettoyer selon le concept hygiénique et les remonter. Suivre les consignes détaillées « Démontage sortie de lait et de café » inscrites sur la face arrière.

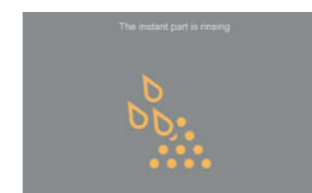

La machine à café automatique exécute un rinçage instantané.

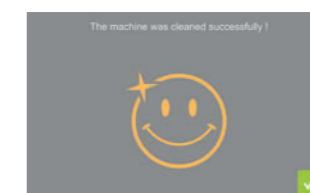

Le nettoyage a été effectué. Appuyer sur l'écran tactile pour terminer le programme.



Si le nettoyage forcé a été activé, ce message sera affiché si nécessaire.



Ce message apparaît si le processus de nettoyage a été interrompu. Appuyer sur l'écran tactile pour poursuivre le nettoyage.

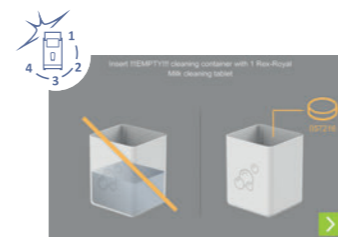

Vider le récipient de nettoyage, le nettoyer et sécher. Enlever également la saleté et le givre dans le réfrigérateur.



Démontage sortie de lait et de café

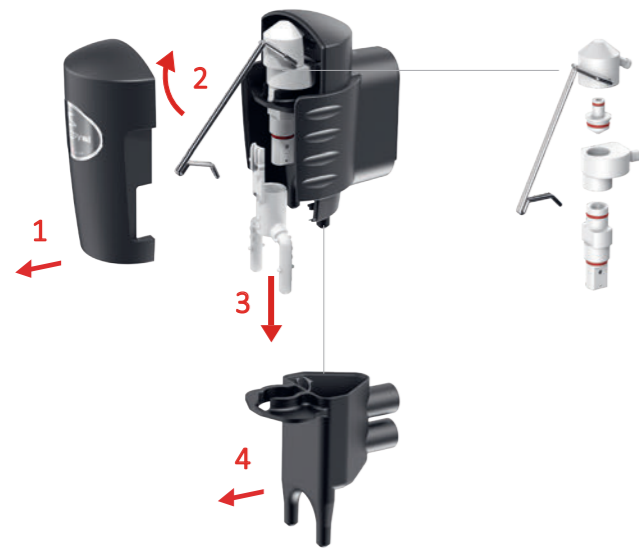

Démontage unité de mélange d'instantané / mélangeur d'instantané



Utilisation des outils de nettoyage

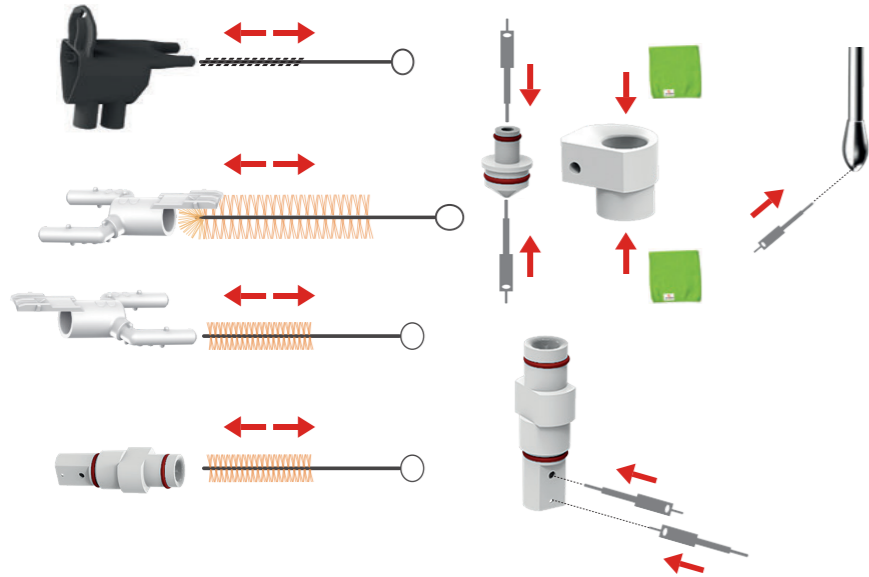

Nettoyage quotidien

Les composants suivants doivent être nettoyés manuellement au quotidien pendant le processus de nettoyage automatique. A cet effet suivre le concept hygiénique Rex-Royal tel que décrit à la première page.



Vider et nettoyer le bac à marc.



Vider le lait et nettoyer le récipient de lait.



Démonter et nettoyer le moussEUR à lait. Voir « Démontage sortie de lait » !



Démonter et nettoyer l'unité de mélange d'instantané. Voir « Démontage unité de mélange d'instantané » !



Démonter et nettoyer le mélangeur d'instantané. Voir « Démontage mélangeur d'instantané » ! Veiller à ce que le mélangeur d'instantané soit correctement replacé après nettoyage.

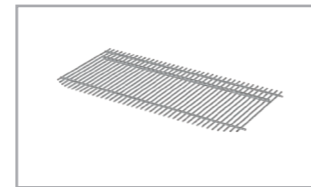

Retirer la grille égouttoir du bac de récupération d'eau résiduelle et la nettoyer.



Vider et nettoyer le bac de récupération d'eau résiduelle.



Nettoyer avec le chiffon microfibre l'unité de refroidissement, le dispositif d'aspiration du lait et les conduites. Puis pulvériser de désinfectant et laisser sécher.

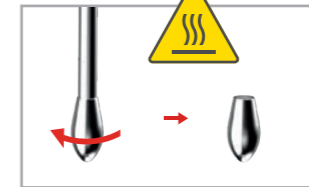

Risque de brûlures !
Éteindre la machine à café automatique.
Dévisser la buse de vapeur et nettoyer tous les composants individuels de l'intérieur et de l'extérieur. Revissez ensuite la buse de vapeur.

Nettoyage hebdomadaire



Démonter la buse de vapeur située dans le moussEUR à lait et la nettoyer. Voir « Démontage sortie de lait » !

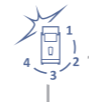

Démonter et nettoyer la sortie de café. Voir « Démontage sortie de café » !



Démonter le récipient de café et d'instantané, enlever tous les résidus au moyen d'un nettoyant doux et bien sécher.



Nettoyer la face extérieure de la machine à café automatique avec le chiffon microfibre. Pulvériser le spray désinfectant et laisser sécher.

Reinigingshandleiding

Rex-Royal S300 | Rex-Royal S500

met AutoClean

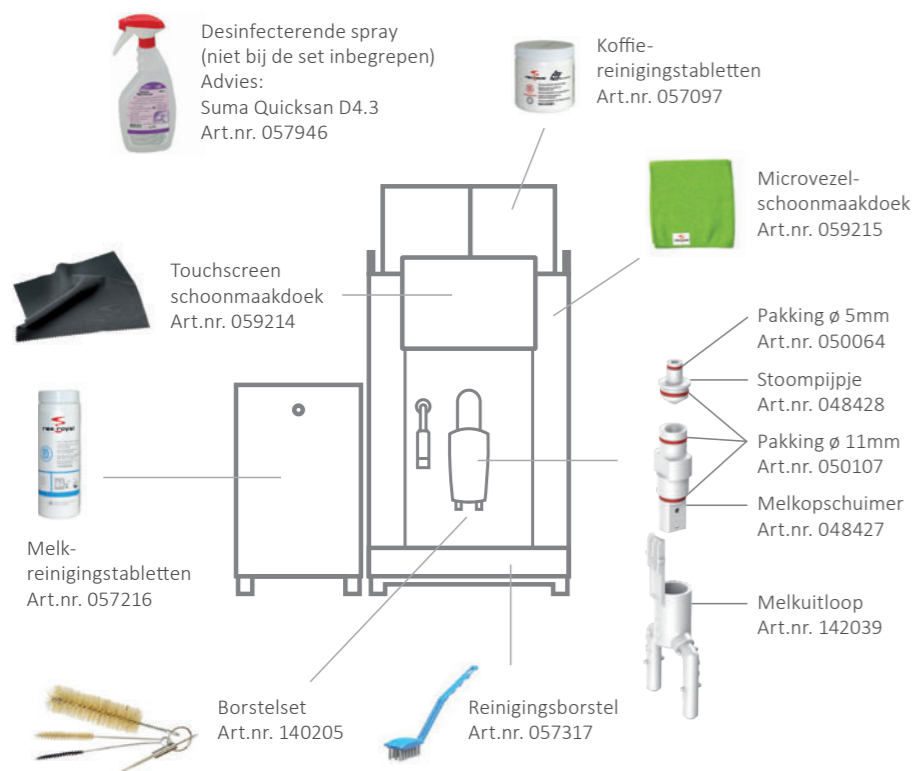

Belangrijke informatie

- Dagelijks moeten alle systemen worden gereinigd die minstens één keer gebruikt zijn.
- Afhankelijk van de instelling moet het reinigingsproces handmatig worden gestart, of de koffiemachine verlangt op geprogrammeerde tijden een reiniging.
- Gebruik alleen de hierboven vermelde reinigingsmiddelen omdat deze optimaal op het automatische reinigingsprogramma zijn afgestemd. Neem vóór het gebruik van de reinigingsmiddelen de betreffende veiligheidsinstructies op de verpakking in acht. Vraag naar de veiligheidsinformatiebladen indien de veiligheidsinstructies in uw taal niet zijn afgedrukt.
- De bestanddelen van het reinigingsmiddel kunnen oog- en huidirritatie veroorzaken alsook schade toebrengen aan de gezondheid wanneer deze worden ingeademd of doorgeslikt.
- De reinigingsmiddelen moeten buiten bereik van kinderen afgesloten worden bewaard en mogen alleen bereikbaar zijn voor bevoegde personen. De fabrikant is niet verantwoordelijk voor misbruik.
- Draag indien mogelijk altijd beschermende handschoenen.
- Open tijdens het reinigingsproces nooit de voordeur en verwijder ook nooit de lekbak, behalve wanneer dit door de koffiemachine wordt aangegeven.
- Schakel de koffiemachine tijdens het reinigingsproces niet uit.
- Risico op brandwonden door hete vloeistoffen of stoom.
- Raak tijdens het automatische reinigingsproces geen uitloop aan, plaats uw hand niet in het bereik van de uitgifte. Raak het touchscreen alleen aan als hierom wordt verzocht.
- Reinig de koffiemachine niet met een waterstraal of hogedrukreiniger en giet nooit water over het apparaat.
- Houd de microvezeldoek en reinigingsborstels altijd schoon en droog. Was de microvezeldoek en reinigingsborstels regelmatig.

Rex-Royal Hygiëneconcept

Opdat u altijd kunt genieten van perfecte koffie, is een correcte reiniging van de machine van essentieel belang. Lees de informatie in deze reinigingshandleiding en op het touchscreen van uw koffiemachine om de hygiëne hiervan te behouden. In geval van twijfel, kunt u contact opnemen met uw servicepartner of de Rex-Royal AG.

Draag om hygiënische redenen huishoudhandschoenen.

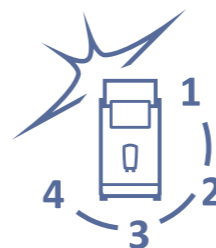

- 1 Inweken/voorspoelen**
Demonteer de onderdelen die moeten worden gereinigd en leg deze in warm water. Gebruik eventueel een mild reinigingsmiddel.
- 2 Resten verwijderen**
Verwijder met behulp van de reinigingsborstels en reinigingsspiraal alle resten en spoel vervolgens af met warm water.
- 3 Drogen**
Droog met de groene microvezeldoek alle onderdelen goed af.
- 4 Desinfecteren**
1 Spray het product onverdund op het schone, droge oppervlak. Het gehele oppervlak moet vochtig zijn.
2 Laat 5 minuten inwerken (volgens EN 1276, EN14476 en DGHM).
3 Laat de oppervlaktes opdrogen, veeg evt. handmatig droog.

Automatisch reinigingsprogramma

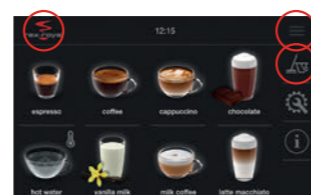

Houd minstens 5 seconden het MENU of LOGO ingedrukt. Druk vervolgens op de toets REINIGEN.

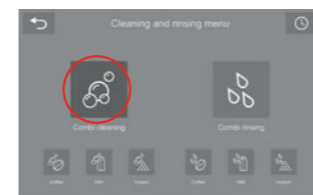

Door op de toets voor COMBI-REINIGING te drukken, wordt het reinigingsproces gestart.



Verwijder de residubak, leeg en reinig deze en plaats hem vervolgens weer terug. Druk vervolgens op de pijltjestoets om naar de volgende stap te gaan.



Open de tabletinworp en werp er een koffie-reinigingstablet in. Schenk vervolgens een dosering melkreinigingsmiddel in de lege reinigings-container.

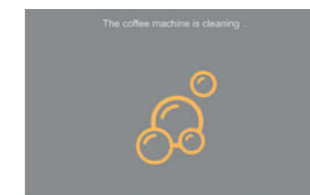

De koffiemachine reinigt... Na een tijdje wordt de volgende stap weergegeven op het beeldscherm.



Demonteer de onderdelen zoals wordt weergegeven op het beeldscherm, reinig deze volgens het hygiëneconcept en monteer ze vervolgens weer. Volg de gedetailleerde instructies voor "Instant-mixeerheid demonteren" op de achterkant.

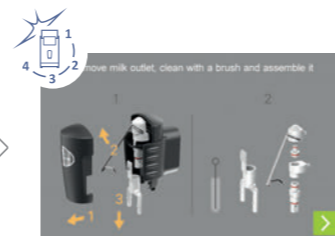

Demonteer de onderdelen zoals wordt weergegeven op het beeldscherm, reinig deze volgens het hygiëneconcept en monteer ze vervolgens weer. Volg de gedetailleerde instructies voor "Melkuitloop/koffie-uitloop demonteren" op de achterkant.

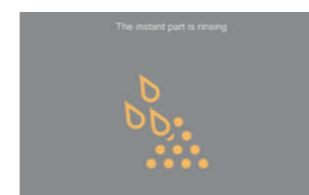

De koffiemachine voert een spoeling uit.



Het reinigingsproces is voltooid. Tik op het touchscreen om het programma te beëindigen.

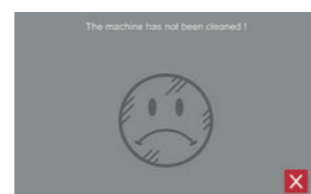

Is de gedwongen reiniging geactiveerd, dan wordt indien nodig deze melding weergegeven.



Als het reinigingsproces is onderbroken, wordt deze melding weergegeven. Tik op het touchscreen om het reinigingsproces voort te zetten.

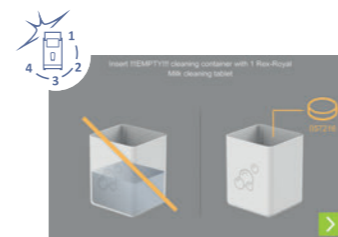

Leeg, reinig en droog het reinigingsreservoir. Verwijder ook vuil en ijsafzetting in de koelkast.



Melk- en koffie-uitloop demonteren

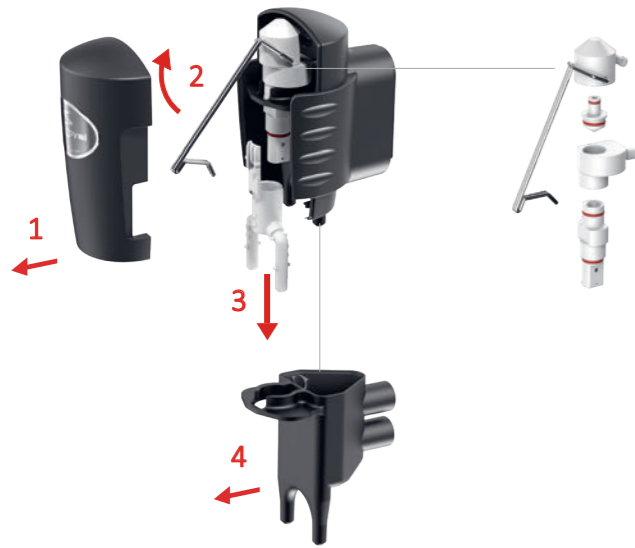

Instant-mixeenheid/instantmixer demonteren

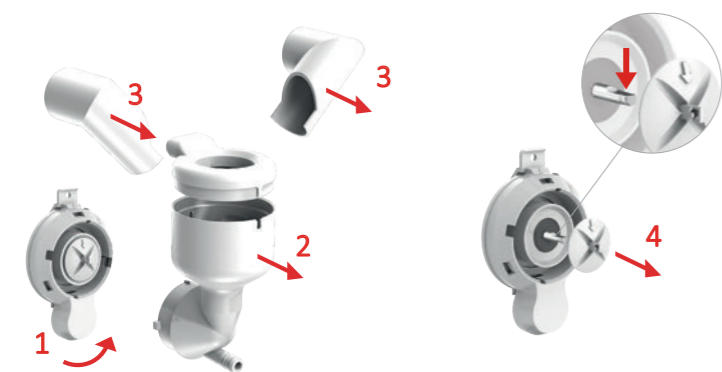

Gebruik van de reinigungsaccessoires

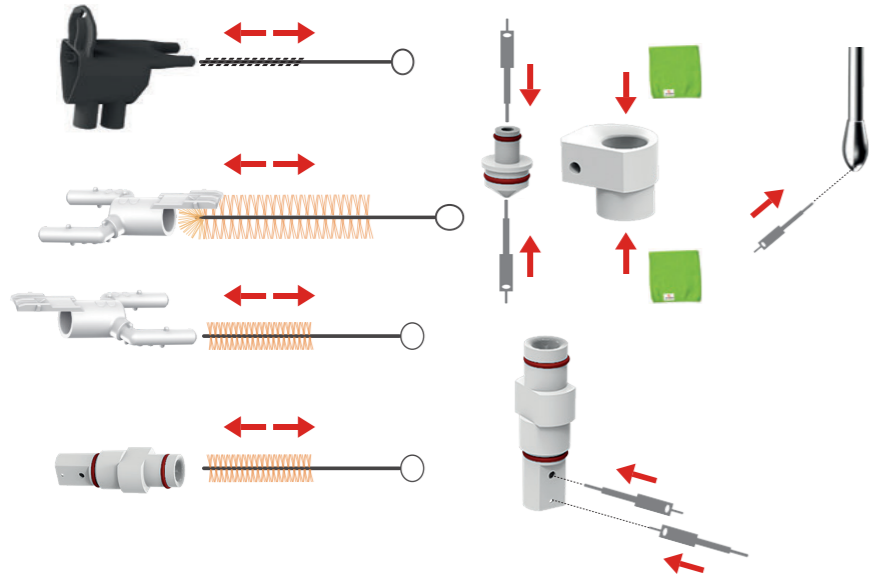

Dagelijks

De volgende onderdelen moeten tijdens de automatische reiniging dagelijks handmatig worden gereinigd. Volg hiervoor het Rex-Royal hygiëneconcept zoals op de eerste pagina vermeld staat.



Leeg en reinig de residubak.



Leeg en reinig het melkreservoir.



Demonteer en reinig de melkopschuimer. Zie "Melkuitloop demonteren"!



Demonteer en reinig de instant-mixeenheid. Zie "Instant-mixeenheid demonteren"!

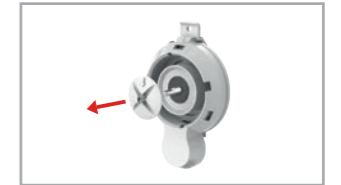

Demonteer en reinig de instant-mixer. Raadpleeg "Instantmixer demonteren"! Zorg ervoor dat de instantmixer na het reinigen correct wordt teruggeplaatst.

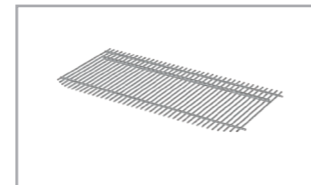

Verwijder en reinig het rooster van de lekbak.



Leeg en reinig de lekbak.



alleen S300



Reinig met de microvezeldoek de koelinstallatie, de melkaanzuiging en -leidingen. Besproei vervolgens met de desinfecterende spray en laat drogen.



Gevaar voor brandwonden!
Schakel de koffiemachine uit.
Schroef het stoompijpje los en reinig de afzonderlijke onderdelen volledig aan binnen- en buitenkant. Schroef het stoompijpje vervolgens weer vast.

Wekelijks



Demonteer en reinig het stoompijpje in de melkopschuimer. Zie "Melkuitloop demonteren"!



Demonteer en reinig de koffie-uitloop. Zie "Koffie-uitloop demonteren"!



Demonteer de koffie-/instantcontainers en verwijder met een mild reinigingsmiddel eventuele resten. Droog vervolgens goed af.



Reinig met een microvezeldoek de buitenkant van de koffiemachine. Besproei met desinfecterende spray en laat dit opdrogen.

清潔指導

Rex-Royal S300 | Rex-Royal S500
with AutoClean

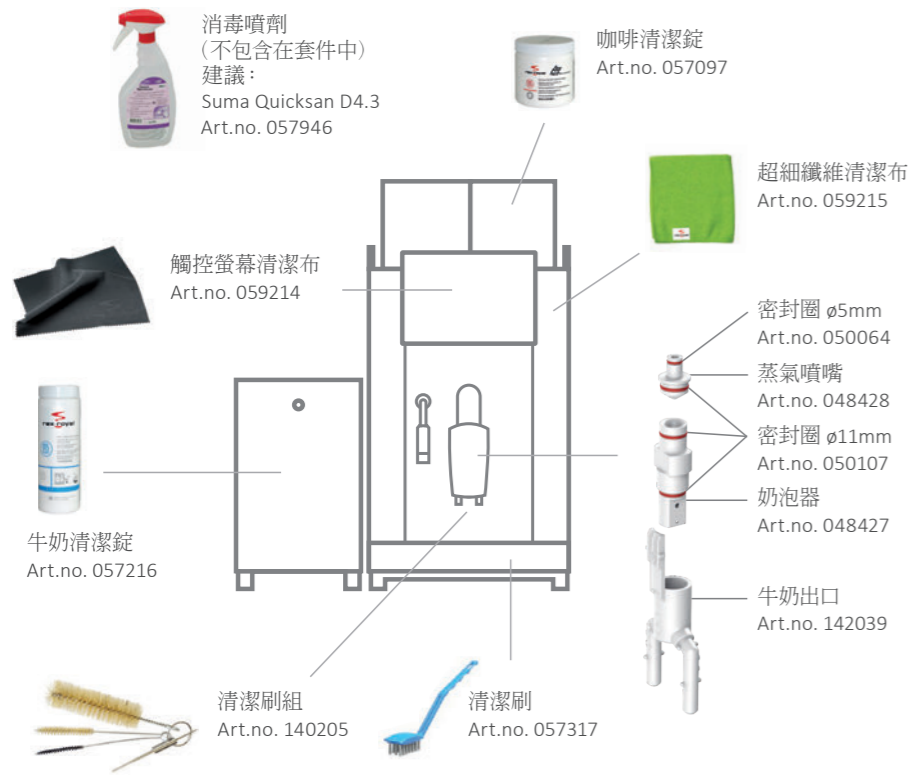

重要資訊

- 所有系統每天只要使用過一次就應清潔。
- 根據設定，必要的清潔程序可透過手動啟動，或者於設定的時間全自動咖啡機會自動啟動清潔程序。
- 僅可使用以上列出的清潔劑，因為它們是最適合用於自動清潔程序。使用清潔劑前請留意包裝上的安全措施。若安全預防措施非繁體中文印刷，請索取安全數據表。
- 清潔劑的成分會刺激眼睛和皮膚，吸入或吞食清潔劑會危害健康。
- 清潔劑必須貯儲在上鎖、孩童無法觸及的地方，且僅可由已授權人員存取。製造商對於不當使用不予負責。
- 盡可能配戴防護手套。
- 除非全自動咖啡機出現相關指示，否則請勿在清潔過程中打開門，也不要移除集水盤。
- 請勿在清潔期間關閉全自動咖啡機的電源。
- 高溫的液體或蒸氣有可能使人燙傷。在自動清潔期間請勿觸碰任何出口，請勿觸碰出料區。僅可在出現相關指示時才可觸碰觸控螢幕。
- 請勿使用水柱或高壓清潔劑清潔全自動咖啡機，也絕不可以將水倒灌在機器上。
- 定期清洗超細纖維清潔布和清潔刷，並且務必保持乾淨與乾燥。

Rex-Royal 衛生概念

欲享受品質一致的完美咖啡，正確的清潔至關重要。請遵循本清潔指南以及全自動咖啡機觸控螢幕上的信息，以保持其衛生。若有任何疑慮，請聯絡您的服務夥伴或 Rex-Royal AG。

基於衛生考量，請使用清潔手套。

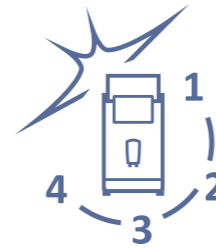

- 浸泡/預沖洗**
拆下欲清潔的組件並將它們置於溫水中。如有需要，請使用中性清潔劑。
- 移除殘渣**
使用清潔刷及清潔刷組清除所有殘渣，再以溫水清洗。
- 乾燥**
使用綠色超細纖維清潔布徹底擦乾所有組件。
- 消毒**
1 將未稀釋的消毒噴劑噴撒在乾淨且乾燥的表面上。確保其完全濕潤。
2 靜置 5 分鐘 (根據 EN 1276、EN14476 和 DGHM 規定)。
3 讓表面自然風乾，必要時徹底擦拭至乾燥。

自動清潔程序

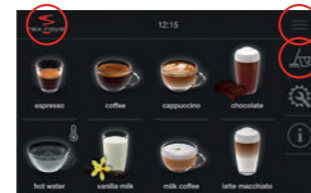

長按選單或商標至少 5 秒鐘。接著按清潔按鈕。



按組合清潔按鈕啟動清潔程序。



移除、清空、清潔並重置咖啡渣容器。然後按箭頭按鍵繼續下一步。

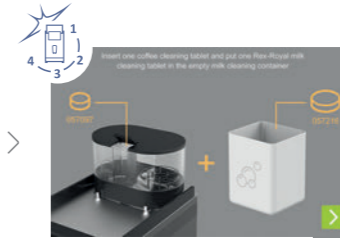

打開清潔錠投入口，放入一顆咖啡清潔錠。然後準備一個乾淨、無異物的清潔容器，於內放置一顆牛奶清潔錠。



咖啡機開始清潔... 螢幕很快就會顯示下一個步驟。

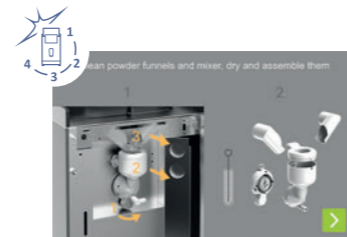

按照螢幕指示拆下組件，並依照衛生概念清潔和重新組裝。請遵循背面所附「拆解即溶粉攪拌裝置」的詳細指示。

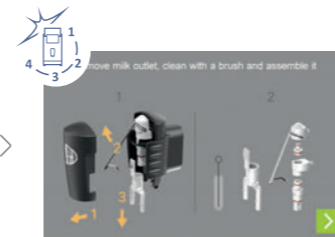

按照螢幕指示拆下組件，並依照衛生概念清潔和更換。請遵循背面所附「拆解奶泡器/咖啡出口」的詳細指示。



研磨咖啡機進行即溶粉部件沖洗。

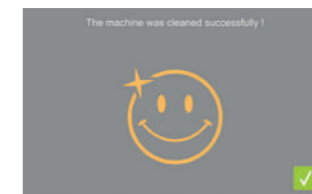

清潔程序完成。輕觸觸控螢幕即結束程序。

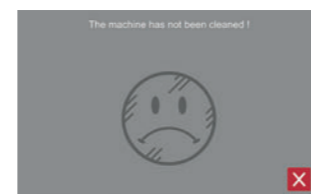

若啟用了強制清潔功能，則會依照要求顯示此訊息。



若中斷了清潔程序，則會顯示此訊息。輕觸觸控螢幕繼續清潔程序。

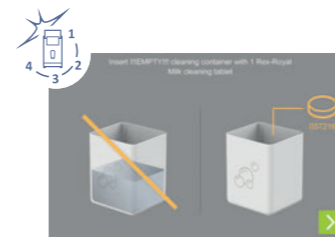

清空、清潔並乾燥清潔容器。然後將牛奶清潔錠插入清潔容器。



拆解牛奶 / 咖啡出口

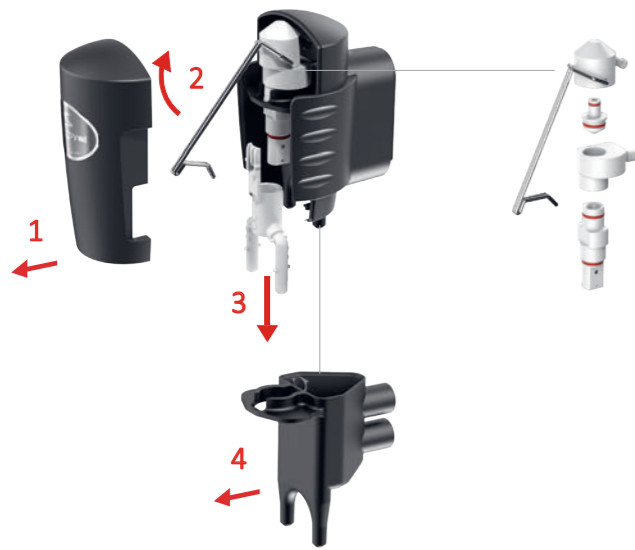

拆解即溶粉攪拌裝置

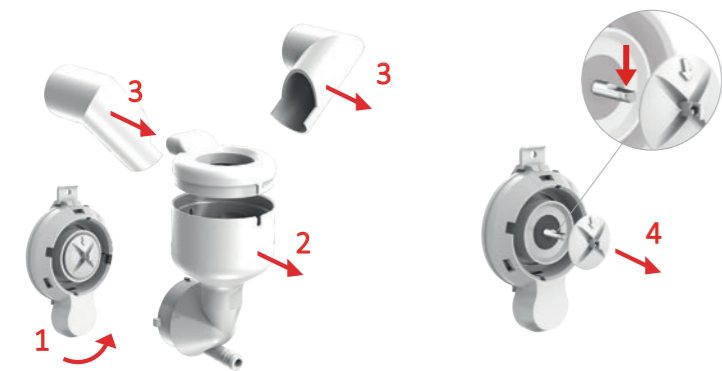

使用清潔用具

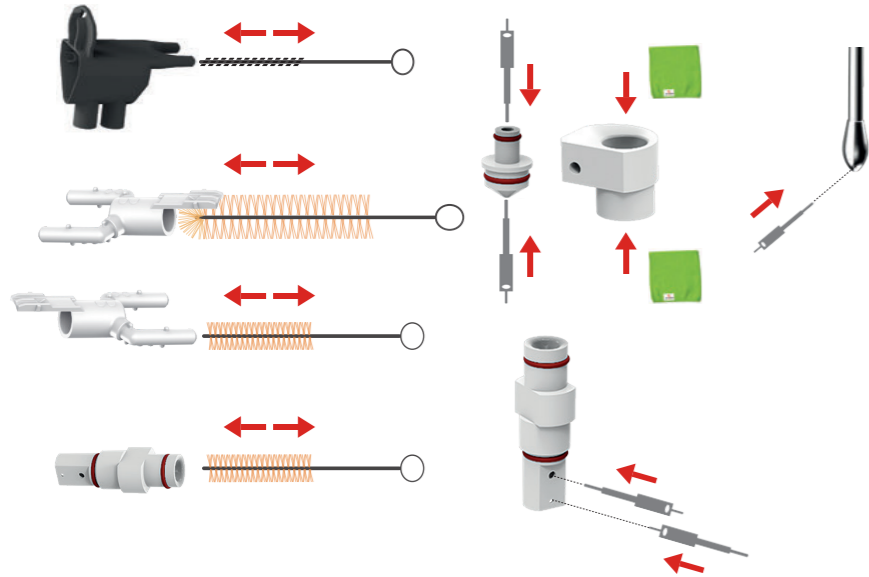

每日清潔

每日在進行自動清潔時，必須手動清潔以下組件。請遵循第一頁Rex-Royal 衛生概念的說明。



清空並清潔咖啡渣容器。



清空牛奶並清潔牛奶容器。



拆下並清潔牛奶發泡器。請參閱「拆解牛奶出口」。



拆解並清潔即溶粉攪拌裝置。請參閱「拆解即溶粉攪拌裝置」。

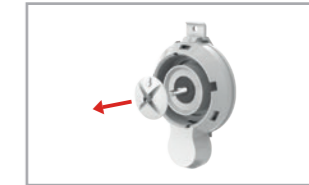

拆解並清潔即溶粉攪拌器。請參閱「拆解即溶粉攪拌裝置」。請確保清潔後正確地裝回即溶粉攪拌器。

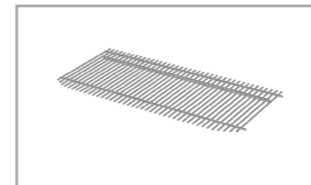

將集剩水盤上的網架取下清潔。



清空並清潔集水盤。



僅 S300



使用超細纖維清潔布清潔冷卻裝置、牛奶吸頭與吸管，最後於其噴撒消毒噴劑後靜置使其乾燥。

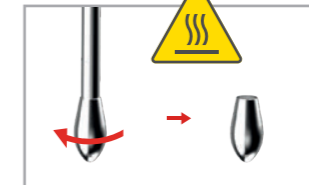

燙傷危險！關閉研磨咖啡機電源。旋轉移除蒸氣噴嘴並徹底清潔它的內外部組件。之後重新將蒸氣噴嘴鎖回。

選配

每週清潔



拆下奶泡器中的蒸氣噴嘴並加以清潔。請參閱「拆解牛奶出口」。



拆下並清潔咖啡出口。請參閱「拆解咖啡出口」。



拆下咖啡豆和即溶粉料容器並使用中性的清潔劑除去任何殘渣並確實乾燥。



使用超細纖維清潔布清潔全自動咖啡機的表面。噴撒消毒噴劑後靜置使其乾燥。